

S (N)

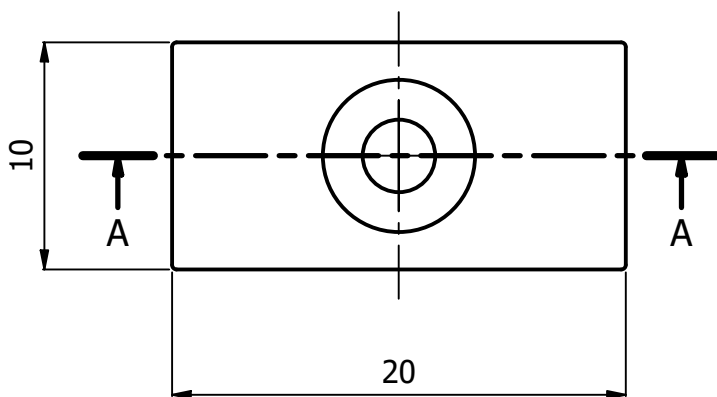

N (S)

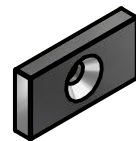

Fissaggio con viti testa svasata
a norma DIN 965 - ISO 7046



Rev.	Descrizione modifiche	Data	Firma

Disegnato M.D.	Data 12/12/2019	Materiale Neodimio	Trattamento Nichelato	Tolleranza +/- 0.1	Unità mm
-------------------	--------------------	-----------------------	--------------------------	-----------------------	-------------

ITALFIT magneti

Via Comelli, 39
33034 Fagagna (Ud)
Tel 0432/801675 Fax 0432/810197
P.IVA e C.F. 02610340305

Descrizione

Blocchetto con foro svasato - magnetizzazione assiale (N + S)

Codice

NQ01.35NI00.2013

Scala

3 : 1

Formato

A4