

A-A (2:1)

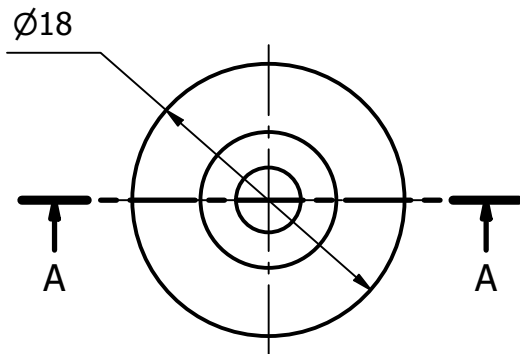

Fissaggio con viti testa svasata  
a norma DIN 965 - ISO 7046

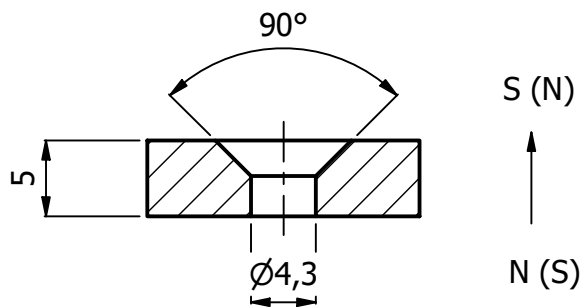

Rev.	Descrizione modifiche	Data	Firma

Disegnato M.D.	Data 23/10/2023	Materiale Neodimio	Trattamento Nichelato	Tolleranza +/- 0.1	Unità mm
-------------------	--------------------	-----------------------	--------------------------	-----------------------	-------------

**ITALFIT magneti**

Via Comelli, 39  
33034 Fagagna (Ud)  
Tel 0432/801675 Fax 0432/810197  
P.IVA e C.F. 02610340305

Descrizione  
**Magnete con foro svasato - magnetizzazione assiale (N+S)**

Codice  
**NS01.35NI00.1854**

Scala  
**2 : 1**

Formato  
**A4**